

## TEMPERATURE FIELDS DEVELOPING IN THE PROCESS OF CUTTING OF SAPPHIRE AND DIAMOND

P. N. Bogdanovich,<sup>a</sup> D. V. Tkachuk,<sup>b</sup>  
and D. A. Bliznets<sup>a</sup>

UDC 536.5:621.891:621.9

*The results of investigation of the temperature fields arising in the process of cutting of crystalline materials are presented. The temperature distributions in the cutting zone and in the neighboring regions were determined with the use of an infrared thermograph. It is shown that, in the process of cutting of sapphire, the temperature reaches a maximum at a certain distance before the cutting zone. With time the temperature of the sapphire increases monotonically or passes through a maximum depending of the load applied. The kinetic dependence of the temperature of diamond also passes through a maximum. It has been established that the temperature of diamond crystal subjected to cutting under hard conditions increases markedly, which can lead to the separation of large parts, probably because of the growth of fatigue cracks due to the intense heating of the material.*

**Keywords:** cutting, sapphire, diamond, temperature, temperature distribution, thermogram.

**Introduction.** Some industries, especially electronics and optical instrument making, are heavy users of crystalline materials, among which are the well-known silicon, germanium, and sapphire crystals and more specific crystals of AsGa, CdZnTe, and other materials [1–3]. It is known that diamond is an excellent jewelry material that can be used for production of different-application sensors as well as components of optoelectronic devices and precision instruments for cosmic applications [4]. A technological operation of the production of electronic and optical elements is the cutting of crystals. In this case, the quality of the cutting is importance because it substantially determines the characteristics of the final product. Control of the cutting process takes on paramount significance for expensive crystals, especially for diamond because, in this case, high quality in processing of the crystal should be combined with minimum loss in its mass.

Currently new methods of cutting of crystals have been developed; however, mechanical cutting remains one of the most popular cutting technologies. It is realized as a result of the abrasive wear of a workpiece by diamond-dust particles found at the edge of a thin metal disk and, as a rule, is accompanied by intense heat release in the zone of contact of the crystal with the disk. The last-mentioned circumstance can substantially influence the quality of the final product, which requires studying the temperature fields in the cutting zone and in its neighborhood. Theoretical methods of calculating the temperature in the process of cutting of crystals are well developed; however, the corresponding experimental methods are not sufficiently advanced. It is known that the temperature in the process of cutting of a diamond can be measured with the use of artificial and natural thermocouples, photoresistors, and radiation pyrometers. In [5], the possibilities and limitations of these methods were considered, and it was shown that there is a need using thermography methods for measuring the temperature in the process of cutting of crystals.

Below are results of investigations of the temperature fields arising in the process of cutting of a sapphire and a diamond, specifically the temperature distributions in the cutting zone and in its neighborhood and the kinetic dependences of the cutting temperature, by the thermography method.

**Experimental Procedure.** The cutting of a sapphire was carried out on a special setup developed by us. This setup comprises a high-speed friction machine and a system for recording the temperature field. The friction machine allows one to simulate the process of cutting at a rate of up to 100 m/sec and a load of 10 N. It is equipped with a

---

<sup>a</sup>Belarusian State University of Transport, 34 Kirov Str., Gomel', 246653, Belarus; <sup>b</sup>V. A. Belyi Institute of Mechanics of Metallopolymeric Systems, 32a Kirov Str., Gomel', 246050, Belarus; email: dvtkachuk@inbox.ru. Translated from *Inzhenerno-Fizicheskii Zhurnal*, Vol. 82, No. 3, pp. 569–575, May–June, 2009. Original article submitted April 9, 2008.

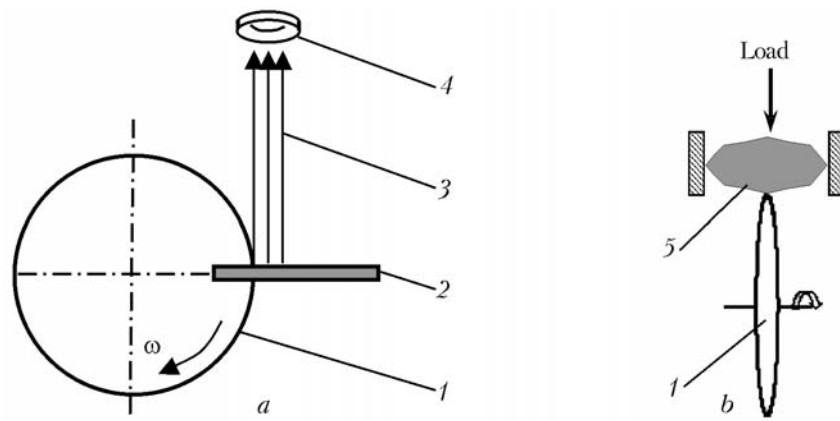

Fig. 1. Diagrams of the contact of a disk with sapphire (a — side view) and a diamond (b — top view) in the process of their cutting: 1) cutting disk; 2) sapphire plate; 3) heat radiation; 4) infrared imager; 5) diamond single crystal.

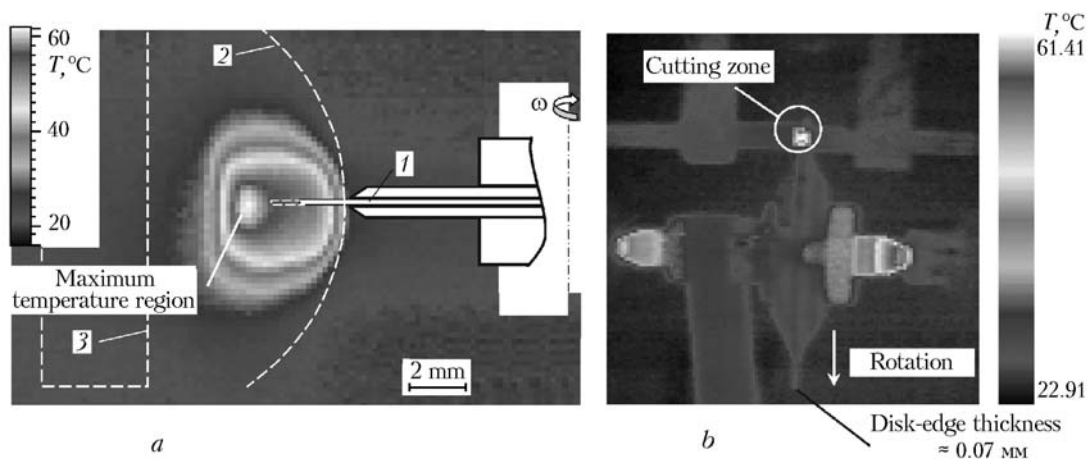

Fig. 2. Thermograms obtained in the process of cutting of sapphire (a) and a diamond (b): 1 — cutting disk; 2 — contour of the sapphire plate; 3 — contour of the holder of the workpiece.

device for measuring the cutting force transformed to the friction coefficient (the ratio between the cutting force and the normal load). The design and work of the experimental setup are described in more detail in [6, 7]. The geometry of the contact is schematically shown in Fig. 1a. The sapphire samples represented round plates of diameter  $18 \times 1$  mm, forming a contact with the edge of a rotating cutting disk. The disks of thickness 0.05–0.07 mm and diameter 76 mm were made from a stannous bronze. Before an experiment and in its process, the cutting edge of the disk was charged every 2–3 min with a diamond powder added to a mixture of drying oil (70–80%) and castor oil (20–30%).

The experiments on the cutting of natural-diamond single crystals were conducted at the brilliant-production plant of the Gomel' Production Association "Kristal" by the standard technology [8] with the use of a multispindle cutting machine. The main element of this machine is a spindle with two flanges at the axis, between which a cutting disk is cramped. The disks and abrasive described above were used. A diamond workpiece was marked out, fixed in a mandrel, oriented, and then cut. The rate of rotation of the machine spindles was 12,000 rpm, which corresponded to the linear velocity 42.6 m/sec. The load was changed from 0.43 to 2.40 N. The scheme of the contact of the cutting disk with the diamond single crystal is presented in Fig. 1b.

The temperature field in the cutting zone was recorded by an IR Snap Shot infrared imager of model 525 (USA) [9], the signal from which was fed to a liquid-crystal monitor. The data obtained were stored in the memory of the infrared imager and then were processed on a personal computer with the use of a special IR Snap View software. One of the main advantages of the infrared imager is a wide measurement range allowing one to record regions

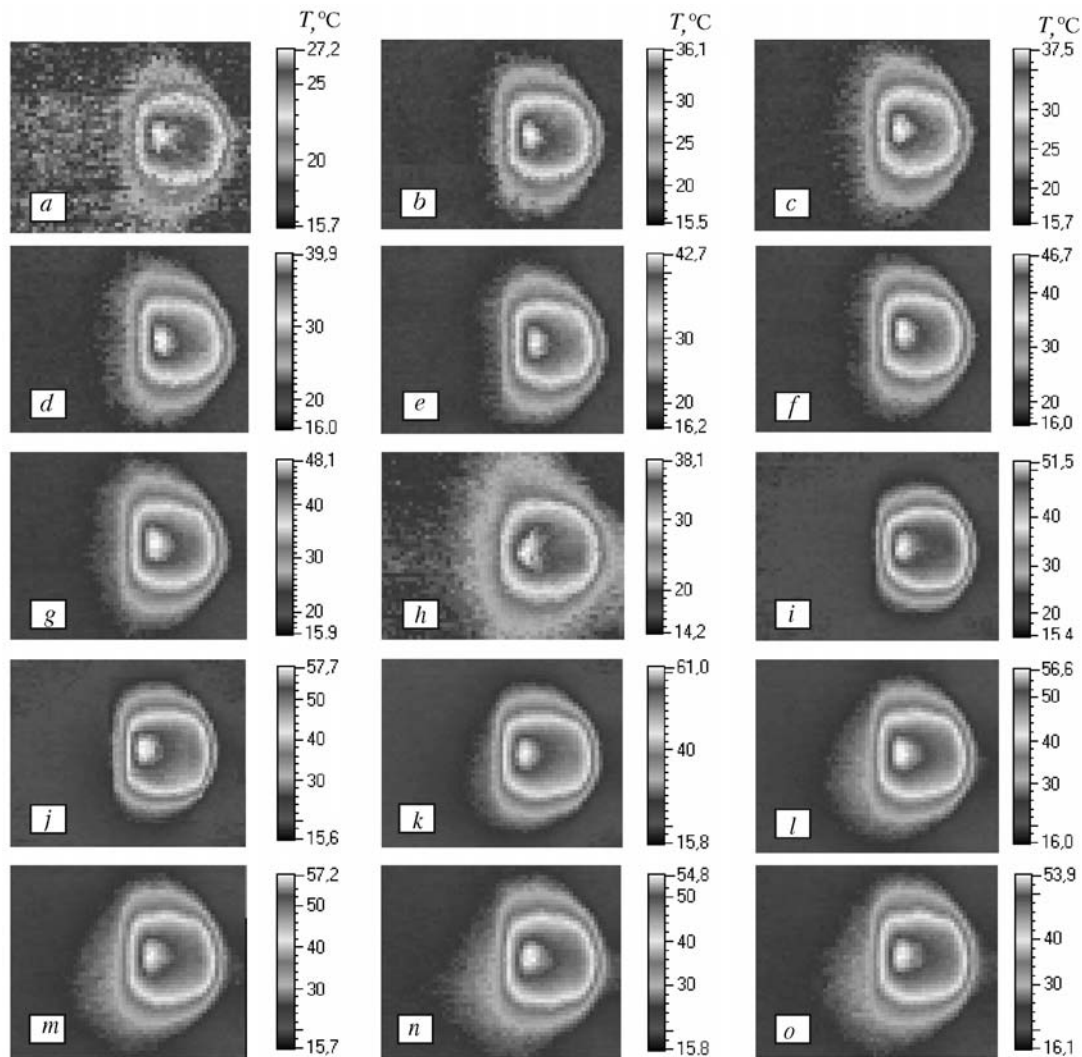

Fig. 3. Kinetic of the temperature field in the zone of cutting of sapphire and in the neighboring regions ( $V = 24.6$  m/sec):  $P = 0.43$  (a–g) and  $0.65$  N (h–o). The time interval between the frames is 30 sec.

with very different temperatures within the limits of one thermogram. The main technical data of the infrared imager are as follows: observation field (angle of view),  $17.2^\circ$  along the horizontal and  $17.2^\circ$  along the vertical; limits of objective focusing, from 260 mm to infinity; spectral range, 8–12  $\mu\text{m}$ ; accuracy of temperature measurement,  $2^\circ\text{C}$  or 2% of the entire scale; threshold of temperature sensitivity at  $30^\circ\text{C}$ , no more than  $0.3^\circ\text{C}$ ; temperature measurement range, from  $-30$  to  $600^\circ\text{C}$ ; scanning time, less than 1.5 sec. To obtain an actual temperature, it is necessary to take into account the temperature of the background and the radiating capacity of the object [10]. In our experiments, the background temperature was assumed to be equal to the ambient temperature ( $21^\circ\text{C}$ ). According to the reference data [11], the radiating capacity of diamond is 0.92 and the radiating capacity of sapphire is 0.59 in the wavelength range (8–12  $\mu\text{m}$ ). Figure 2 presents typical thermograms obtained in the process of cutting of a sapphire and a diamond; they represent temperature distributions in the visual field of the infrared imager.

**Results of Investigations and Their Discussion.** *Cutting of sapphire.* It is seen from the thermogram obtained in the process of cutting of sapphire that, at a rate  $V = 24.6$  m/sec and a load  $P = 0.65$  N, the temperature of the sapphire reaches a maximum value not in the zone of the disk–sapphire contact but at a certain distance before it (the region shown in Fig. 2a). The distance from the point of maximum temperature to the cutting edge invisible in the figure (denoted by the dashed line) is equal to 1 mm. This shift of the temperature maximum from

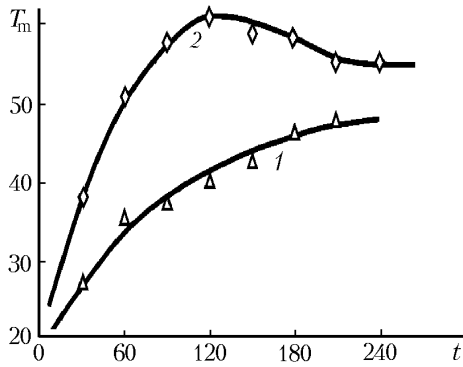

Fig. 4. Kinetic dependences of the maximum temperature recorded in the process of cutting of sapphire ( $V = 24.6$  m/sec):  $P = 0.43$  (1) and  $0.65$  N (2).  $T_m$ , °C;  $t$ , sec.

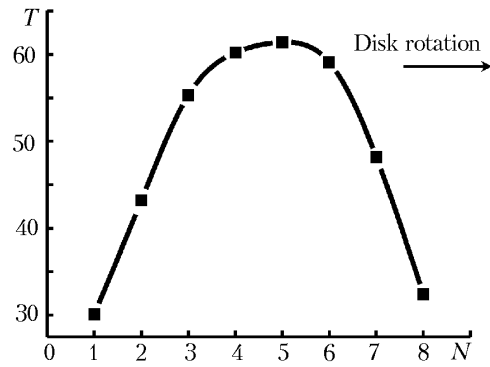

Fig. 5. Typical temperature distribution in the zone of cutting of diamond along the direction of disk rotation.  $N$  is the number of a point,  $T$ , °C.

the zone of contact of the sapphire with the abrasive grains can be due to the following reasons. The heat generated in the sapphire propagates in the direction from the contact zone; however, the sapphire region immediately adjacent to the rotating bronze disk 1 (a narrow strip) is cooled due to the high heat conductivity of the disk. As a result, the temperature of this region decreases. The nonround shape of the thermogram of the region positioned to the left of the maximum-temperature zone, shown in Fig. 2a, is due to the propagation of a large portion of the heat, generated as a result of the cutting, in the plate of the clamping device (its contour is denoted by the dashed line 3) that locates the workpiece.

Since the balance between the amounts of the generated and scattered heat can be disturbed in the process of cutting of solid materials, of interest is determination of the kinetic mechanisms of formation of the temperature fields. Figure 3a–g shows the temperature distributions in the cutting zone and in its neighborhood, recorded at 30 sec intervals from the beginning of the cutting at a load of 0.43 N. The temperature field was not changed significantly with time, excepting the initial moment of the cutting, where the temperature distribution was more diffuse. This, apparently, can be due to both the different heat conductivities of different regions of the sapphire sample and the vibration of the cutting disk. After 30 sec, a cutting strip is formed, the position of the disk is stabilized, all the sapphire regions are heated more uniformly, and, therefore, the contours of the thermograms become more clearly cut. At a load of 0.65 N, analogous temperature distributions (Fig. 3h–o) were recorded.

When the time of cutting increases, the heating of the sapphire in the cutting zone intensifies, i.e., the maximum temperature in the cutting zone  $T_m$  increases (Fig. 4). At a load  $P = 0.43$  N, the temperature of the sapphire increases monotonically (curve 1), and the temperature growth becomes slower within 180 sec after the beginning of the cutting. Such behavior of the kinetic curve reflecting the cutting process can be explained by the influence of the following two factors. The first of them is the accumulation of the cutting heat in the sapphire and, probably, in the working layer of the cutting disk, which serves to increase the sapphire temperature. At  $t < 180$  sec this factor dominates, while the second factor (heat dissipation) is unimportant. The heat transfer from the cutting zone is realized through the heat conduction in the sapphire workpiece and in the constantly cooled bronze disk. The temperature of the sapphire increases with increase in the time of cutting and, as a result, the heat transfer is intensified, which decreases the rate of growth of  $T_m$ .

When the normal load increases to 0.65 N, the maximum temperature increases by approximately 1.3 times. The dependence of  $T_m$  on the time of cutting is schematically represented by the curve with a maximum at  $t = 120$  sec (Fig. 4, curve 2). The left branch of the curve is due to the increase in the heat released in the cutting zone as a result of the increase in the load. After the temperature maximum is attained, the amount of heat generated in the process of cutting becomes equal to the amount of heat dissipated to the environment. The small decrease in the temperature, observed at  $t > 120$  sec, is, evidently, due to the decrease in the distance between the disk and the clamping device and, as a result, the increase in the transfer of heat from the cutting zone. At this point, it should be remem-

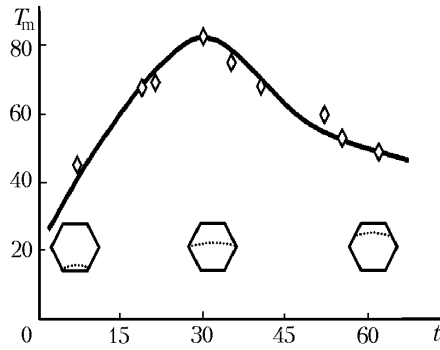

Fig. 6. Typical kinetic dependence of the maximum temperature in the zone of cutting of diamond. In the diagram, the arc of the contact of the cutting disk with the workpiece at different instants of time (dotted line) is shown under the curve.  $T_m$ , °C;  $t$ , min.

bered that at  $P = 0.65$  N the rate of cutting is much higher than that at  $P = 0.43$  N, which provides a more rapid decrease in the distance between the contact zone disk–sapphire and the clamping device.

*Cutting of diamond.* Unlike the cutting of sapphire, the rate of cutting of a diamond crystal is an order of magnitude lower because the large hardness of the latter prevents the penetration of abrasive particles to a large depth into it and serves to wear and dull the cutting edges. The last-mentioned circumstance is a reason for the intense heat release in the cutting zone and the increase in the temperature of the crystal. Under similar loading conditions,  $T_m$  of diamond is 2–10 times higher than  $T_m$  of sapphire.

For the construction of the temperature distribution along the cutting direction, the part of the thermogram corresponding to the cutting zone (denoted by the small circle in Fig. 2b) was magnified and, on it, eight points lying on the line parallel to the direction of the disk rotation were marked with the use of the SnapView-program instrument. The temperature was determined at each point, and the data obtained were used for construction of the temperature distribution (Fig. 5). The temperature distribution in the cutting zone was inhomogeneous; a higher value of  $T$  was recorded in the central region. The left branch is somewhat more gentle than the right one; it corresponds to the entering of the disk to the cutting zone. The cold particles of the diamond powder, found at the edge of the disk, come in contact with the workpiece. In the cutting zone these particles are heated to a temperature that increases as they move to the output of the contact. Therefore, the temperature at the output of the cutting zone is somewhat higher than the temperature at its input. This temperature distribution along the length of the contact is characteristic of a moving single heat source (a spot of an actual contact), which follows from the classical solutions of the heat friction problem [12] and from the experimental data on the temperature in a high-rate frictional contact [13]. It should be noted that, in this case, not the local temperature but the averaged one resulting from the action of a large amount of diamond-powder grains on the workpiece is recorded. It may be suggested that the temperature distribution for a spot of the contact of an individual grain is even more asymmetric.

In the period of time where the depth of cutting does not exceed half the transverse size of a crystal, the kinetic dependence of the maximum temperature in the cutting zone is similar to the analogous dependence for sapphire and is explained by the action of the same factors. A characteristic feature of diamond, as compared to sapphire, is that, at one and the same depth of cut, the time of cutting of a diamond is much longer and the rate of increasing its temperature is, as a rule, larger.

A typical curve reflecting the time dependence of  $T_m$  within the time interval from the beginning of the cutting of a diamond crystal to its end is presented in Fig. 6. It is seen that, at the initial moment of cutting, where the depth of penetration of the disk into the material is small, the temperature of the diamond insignificantly exceeds the ambient temperature. With time, the depth of penetration of the disk into the diamond and the arc of the contact increase. Because of this the abrasive grains are in contact with diamond for a longer time, which leads to the generation of a larger amount of heat and to an increase in the temperature. As the time of cutting increases, the cross section of the crystal part remaining uncut, representing a sink of heat, decreases, which also leads to an increase in the temperature of the cutting zone. The temperature of the diamond increases as long as the arc of the contact in-

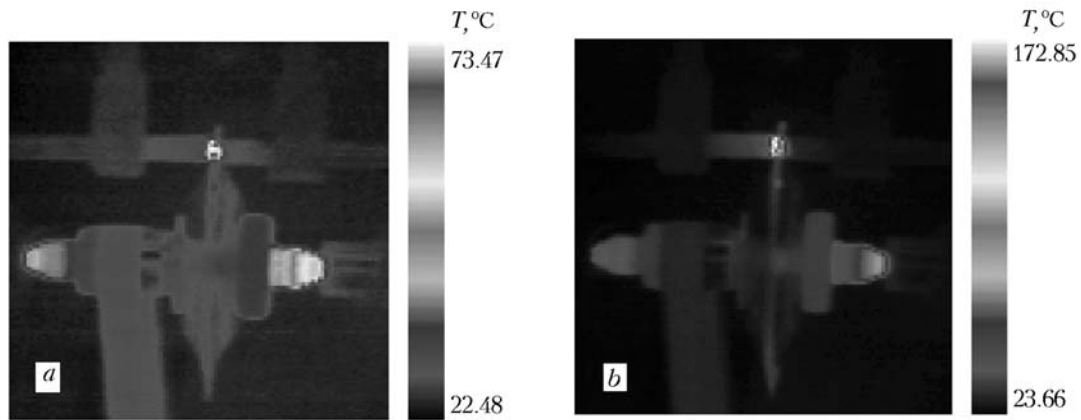

Fig. 7. Thermograms obtained in the process of cutting of diamond at  $P = 1.9$  (a) and 2.1 N (b). The time interval between the frames is 2 min.

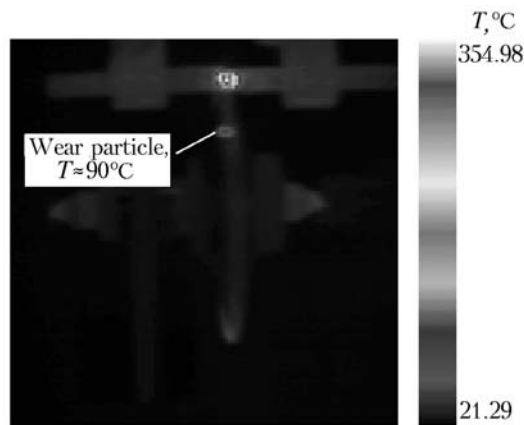

Fig. 8. Thermograms obtained in the process of cutting of a strained diamond single crystal at  $P = 2.4$  N.

creases. After the temperature reaches a maximum, it begins to decrease (the right branch of the curve) because the contact arc becomes shorter and the time of contact of the abrasive grains with diamond decreases, with the result that the intensity of heat release in the cutting zone becomes lower.

The time of cutting of a diamond single crystal depends, in the general case, on its stress-strain state, which is determined by the shape and size of the crystal and the existence of defects in its structure. The conditions of cutting are determined by the strength of the diamond. The rate of rotation of the disk is kept, as a rule, at a constant level. If the workpiece is cut slowly, the load is increased, which can lead to a marked increase in the cutting-zone temperature. For example, as is shown in Fig. 7a, in the steady-state regime of cutting, where the cutting rate and the load are constant, the temperature does not exceed  $\sim 73.5^{\circ}\text{C}$ . After this thermogram has been recorded, the load was increased by approximately 10% and, after 2 min, the maximum temperature in the cutting zone increased by approximately  $100^{\circ}\text{C}$  (Fig. 7b).

The temperature of the diamond can reach even higher values. For example, the thermogram recorded within 21 min after the beginning of the cutting (Fig. 8) shows that the temperature of the workpiece is higher than  $350^{\circ}\text{C}$ . In [14], the average temperature in the zone of cutting of natural-diamond crystals was measured by chromel-alumel microthermocouples. They were positioned in a model workpiece representing a crystal cut in advance into two pieces that were then connected together; the junctions of the thermocouples were between the halves the crystal. The kinetic dependence of the temperature is similar to the dependence presented in Fig. 6. As for the temperatures, even under harder conditions of loading (at a linear velocity of the disk of 54.3 m/sec and a load of 2.5 N), they do not exceed  $200\text{--}220^{\circ}\text{C}$ ; these values are 1.5 times smaller than those measured by the infrared imager (Fig. 8). This points to the fact that the temperature measured in the cutting zone by the artificial thermocouples is underestimated.

As for the application of a 525 IR Snap Shot infrared imager for determining the temperature field in the zone of cutting of a diamond crystal, it should be noted that devices of this type measure the average temperature of the workpiece. The local temperatures established in spots of the contact of the diamond-powder grains with the crystal being processed are evidently much higher. Under extremum cutting conditions, the thermal effects can significantly contribute to the wear of the diamond; they not only give rise to the process of its graphitization, but also enhance the development of fatigue cracks arising as a result of the mechanical wear. An indirect evidence of this is the appearance of heated spots (seen on the thermograms) at the edge of the cutting disk under hard cutting conditions. In particular, for the crystal, the thermogram of which is shown in Fig. 8, this effect manifests itself at a cutting-zone temperature of 262–355°C and is absent at lower loads and, consequently, lower temperatures. The spot having a temperature of ~90°C is evidently due to a fairly large diamond-wear particle.

**Conclusions.** Model experiments with sapphire polycrystals and natural experiments with natural-diamond single crystals have been carried out for the purpose of investigating the thermal processes arising in crystals. The temperature field in the cutting zone was measured with the use of a 525 IR Snap Shot infrared imager. The advantages of this method over the artificial-thermocouple method are that it provides a more adequate estimation of the temperature and a higher accuracy of its measurement, the possibility of determination of the temperature distribution in the cutting zone, the performance of measurements under the conditions of real processing of crystals because of the absence of the need for the installation of a thermocouple in a workpiece, and a convenience in the processing and storage of data.

It has been established that, in the process of cutting of sapphire, the maximum-temperature region is found not in the zone of contact of a cutting disk with the workpiece but at a certain distance before it. This is explained by the difference between the rates of the heat transfer to the disk and to the crystal. As the time of cutting of a sapphire increases, the maximum temperature substantially increases, while the temperature distribution in the cutting zone and in its neighborhood remains practically unchanged. The kinetic dependence of the maximum cutting temperature is monotonically increasing, and, at high loads, it can pass through a maximum.

At the initial stages of the cutting of a diamond single crystal, where the cutting edge of a disk penetrates into it at a depth smaller than half its thickness, the kinetic dependence of the maximum temperature is similar to the corresponding increasing dependence obtained for sapphire. A distinguishing feature of diamond as compared to sapphire is that the time of cutting is many times larger, the cutting temperature is 2–10 times higher, and the rate of increasing this temperature with time is also larger. This can be explained by the extreme hardness of diamond, exceeding that of sapphire by approximately five times. As the time of cutting increases, the maximum temperature in the cutting zone grows because of the increase in the length of the arc of the contact of the disk with the workpiece and, as a consequence, the increase in the time of action of the abrasive grains on the diamond. At the second stage of the cutting, the contact-arc length decreases gradually, which leads to a decrease in the maximum cutting temperature.

A small (of the order of 10%) increase in the load can cause a significant increase (by more than two times) in the temperature of the cutting zone of a diamond. The maximum temperature of cutting of high-strength crystals under the most hard conditions reaches 350°C. In these cases, fairly large diamond-wear particles can separate as a result of the thermally initiated growth of fatigue cracks; these particles show up on the thermograms as heated spots located at the cutting edge of the disk.

## NOTATION

$P$ , load, N;  $t$ , time, sec;  $T$ , temperature; °C;  $V$ , linear velocity of the cutting disk, m/sec;  $\omega$ , angular velocity of the cutting disk, rpm. Subscripts: m, maximum.

## REFERENCES

1. D. K. Ferry and J. P. Bird, *Electronic Materials and Devices*, Elsevier, Amsterdam (2001).
2. H. Nalwa (Ed.), *Handbook of Advanced Electronic and Photonic Materials and Devices*, Elsevier, Amsterdam (2001).
3. J. Simmons, *Optical Materials*. Academic Press, New York (2007).

4. P. P. Shamaev, A. S. Grigor'eva, and V. V. Botvin, On thermochemical methods of processing of diamonds from new positions, *Science and Engineering in Yakutia*, No. 1, 27–29 (2002).
5. P. N. Bogdanovich, D. V. Tkachuk, and V. M. Belov, Methods of recording of the temperature of solid bodies in the process of their friction and mechanical processing (Review), *Trenie Iznos*, **27**, No. 4, 444–456 (2006).
6. D. V. Tkachuk, P. N. Bogdanovich, and V. M. Belov, Method of determining temperature fields in rubbing solid contacts, *Tribotest J.*, **11**, No. 2, 125–135 (2004).
7. P. N. Bogdanovich, V. M. Belov, and D. V. Tkachuk, Experimental setup for studying the thermal processes in the contact between solid bodies, *Materialy, Tekhnologii, Instrumenty*, **11**, No. 4, 89–97 (2006).
8. A. M. Bocharov, *Wear of Diamond Single Crystals and Development of Methods for Increasing the Efficiency of Diamond Processing*, Candidate Dissertation (in Engineering), Gomel' (1986).
9. *IR Snap Shot Infrared Imager of model 525, User's Manual*, TEKHNO, St. Petersburg (2002).
10. G. Gaussorgues, *Infrared Thermography* [Russian translation], Mir, Moscow (1988).
11. F. Lineveg, *Temperature Measurement in Engineering and Technology: Handbook* [Russian translation], Metallurgiya, Moscow (1980).
12. H. Blok, Theoretical study of temperature rise at surfaces of actual contact under oiliness lubricating conditions, in: *Proc. Inst. Mech. Eng.*, **2**, (1937), pp. 222–235.
13. P. N. Bogdanovich and D. V. Tkachuk, Temperature distribution over contact area and "hot spots" in rubbing solid contact, *Tribol. Int.*, **39**, No. 11, 1355–1360 (2006).
14. V. I. Epifanov, V. I. Kononenko, and A. V. Soltan, Temperature measurement in the process of cutting of natural diamond crystals, *Almaz*, No. 4, 3–4 (1973).